

SENCOR®

SJE 5050SS



EN ■ Juicer

READ CAREFULLY AND STORE FOR FUTURE USE.

- This appliance may be used by persons with physical or mental impairments or by inexperienced persons, if they are properly supervised or have been informed about how to use the appliance in a safe manner and understand the potential dangers. Children must not use this appliance or play with it. Keep the appliance and its power cord out of their reach.
- Before connecting the appliance to a power socket, check that the voltage on its rating label matches the electrical voltage in the power socket.
- Connect the appliance only to a properly grounded socket.
- This appliance is intended for processing a standard amount of fruit and vegetables in the household. Do not use it for any other purposes than those intended.
- Do not use the appliance in an industrial environment or outdoors.
- Only place the appliance on an even, dry and stable surface.
- Do not place the appliance on or near devices that are a source of heat.
- Never use accessories, which have not been supplied with this appliance or which have not been explicitly recommended by the manufacturer for this appliance.
- When handling the rotary strainer, be very careful not to injure yourself on its sharp blades.
- Do not use the appliance if the strainer is damaged.
- Make sure that the appliance is correctly assembled before putting it into operation.

**Warning:**

Improper use can lead to injury.

- Prior to juicing, remove hard stones that are contained in, for example, apricots, peaches, mangoes, etc. and inedible peels, e.g. from oranges, pineapples, melons, mandarins, etc.
- Do not use the juicer for processing frozen or excessively hard ingredients, e.g. sugar cane.
- Always use the supplied pusher to push the fruit and vegetables through the feed tube. Never use your hands or other items.
- Always turn off the appliance and disconnect it from the power socket if you will not be using it and if you are leaving it without supervision, before assembly, disassembly or cleaning.
- Prior to removing accessories or parts that move during use, check that the appliance is turned off and disconnected from the power socket and wait until the moving parts come to a stop.

- Do not wash the base unit of the appliance under running water or submerge it in water or another liquid.
- Ensure that the power plug contacts do not come into contact with water or moisture.
- Do not place heavy items on the power cord. Make sure the power cord does not hang over the edge of a table or that it is not touching a hot surface.
- Do not disconnect the appliance from the power socket by pulling on the power cord. This could damage the power cord or the power socket. Disconnect the cord from the power socket by gently pulling on the plug of the power cord.
- It is forbidden to use the appliance if it has a damaged power cord or plug. If the power cord is damaged, have it replaced at a professional service centre.
- Do not use the appliance if its strainer or any other part of the appliance is damaged. To prevent causing a dangerous situation, do not repair the appliance yourself. Have all repairs or adjustments performed at an authorised service centre. By tampering with the appliance you risk voiding your legal rights arising from unsatisfactory performance or quality warranty.

A

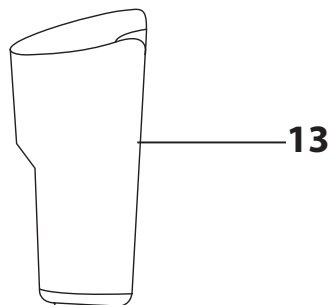
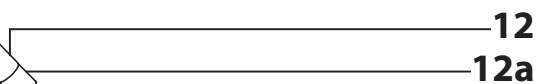
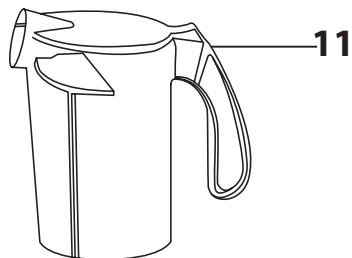
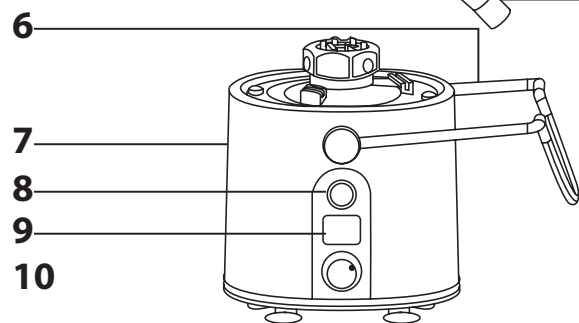
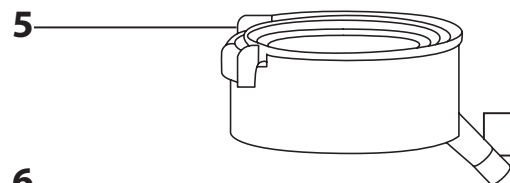
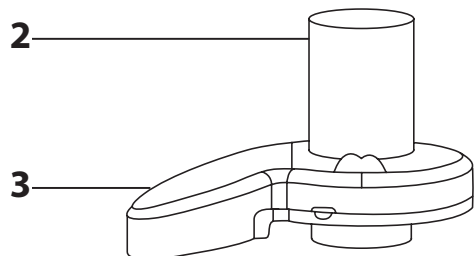

B

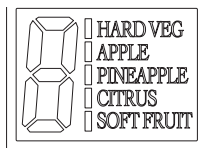

▮ HARD VEG
▮ APPLE
▮ PINEAPPLE
▮ CITRUS
∞ SOFT FRUIT

C

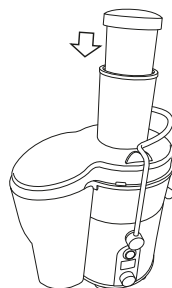
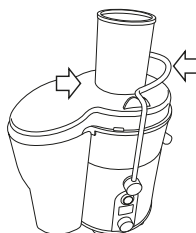
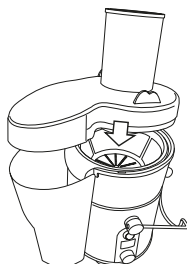
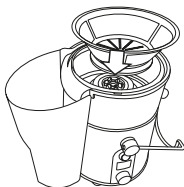
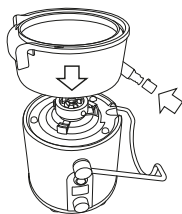

EN Juicer

User's manual

Prior to using this appliance, please read the user's manual thoroughly, even in cases where you have previously familiarised yourself with the operation of similar types of appliances. Only use the appliance in the manner described in this user's manual. Keep this user's manual in a safe place where it can be easily retrieved for future reference.

We recommend saving the original cardboard box, packaging material, purchase receipt and responsibility statement of the vendor and warranty card for at least the duration of the legal liability for unsatisfactory performance or quality. In the event of transportation, we recommend that you pack the appliance in the original box from the manufacturer.

DESCRIPTION OF THE JUICER

A1 Pusher	A9 LCD speed indicator
A2 Feed tube	A10 Control button
A3 Lid	A11 Juice jug
A4 Titanium strainer	A12 Spout with DripStop technology
A5 Juice collector	A12a , which serves to prevent dripping after extraction
A6 Locking arm	A13 Pulp container
A7 Base unit	
A8 0/I switch	

LCD SPEED INDICATOR

- Level 1 – SOFT FRUIT: soft fruit
- Level 2 – CITRUS: citrus fruits
- Level 3 – PINEAPPLE: pineapple and fruits of similar hardness
- Level 4 – APPLE: apples
- Level 5 – HARD VEG: harder vegetables

BEFORE FIRST USE

- Remove all packaging materials from the appliance and its accessories.
- Thoroughly wash all removable parts (pusher **A1**, lid **A3**, titanium strainer **A4**, juice collector **A5**, the juice jug **A11** and pulp container **A13**) that come into contact with food in warm water using kitchen detergent. Then rinse all these parts under clean running water and thoroughly wipe dry with a fine wiping cloth.
- The pusher **A1**, titanium strainer **A4** and the pulp container **A13** may be washed in a dishwasher. We recommend washing the titanium strainer **A4** in the top rack of the dishwasher.



Attention:

The blade at the bottom of the titanium strainer **A4** is very sharp and so it is necessary to be especially careful when handling it. Careless handling may lead to injury.

ASSEMBLING THE JUICER

- Place the juicer on an even, dry surface, e.g. on a work table. Prior to assembly, always check that the juicer is turned off (switch 0/I **A8** is in position 0 – turned off) and the power cord is disconnected from the power source.
- Insert the juice collector **A5** into the juicer – base unit **A7** as shown in the picture. Make sure that the juice collector spout **A12** is located in the groove in the base unit. Place the DripStop **A12a** on to the spout **A12**.
- Insert the titanium strainer **A4** into the juice collector **A5**. Make sure that the strainer is properly seated on the drive shaft.
- Tilt the pulp container **A13** with its upper edge towards the base unit **A7** and slide it from underneath on to the rim of the juice collector. Then push the bottom of the pulp container towards the base unit. When correctly seated, there should be a space of no more than 1 mm between the pulp container **A13** and the base unit.
- Cover everything with the lid **A3** and push it down into the correct position.
- Use one hand to push the lid **A3** downwards and at the same time tilt the locking arm **A6** on to it so that the lid is secured in the correct position. An audible click will be heard. The juicer is equipped with a safety mechanism that prevents it from being started unless the lid is correctly seated and secured in place with the locking arm.
- Place the juice jug **A11** underneath the spout **A12**.
- Insert the pusher **A1** into the feed tube **A2** hole. Notice, that to make movement easier, the pusher **A1** has grooves that slide over the tabs in the top part of the feed tube **A2**.
- The juicer is now assembled and ready for use.

USING THE JUICER

- Make sure that the juicer is correctly assembled and then connect it to the el. power socket. The juicer is equipped with a safety mechanism that prevents it from being started unless it is correctly assembled.
- Place the juice jug **A11**, a glass or another suitable container below the juice spout **A12**. Check that the pulp container **A6** is installed in its place. Check the DripStop **A12a**, it should be turned to the right to enable the juice to flow through from underneath.

- Prepare ingredients suitable for juicing (fruit and vegetables). Thoroughly wash them and cut them up into pieces that will pass through the feed tube **A2**. Remove hard stones that are contained in, for example, apricots, peaches, mangoes, etc. and inedible peels, e.g. from oranges, pineapples, melons, mandarins, etc.
- Prior to starting the juicer, make sure that the lid **A3** is properly secured in the correct position. Using the control button **A10**, set the required level depending on the hardness of the ingredients. The juicer can be set from the lowest level 1 (which is intended for soft ingredients, e.g. bilberries, water melon, tomatoes) to the highest level 5 (which is intended for hard ingredients, e.g. celery, beetroot, etc.).
- Turn on the juicer (set the 0/I switch **A8** to position 1 – on). The level 1–5 can be set during the juicing process depending on the hardness of the ingredients. Take the pusher **A1** out of the feed tube **A2**. Gradually add the prepared ingredients into the feed tube **A2** and push them down using the pusher. You will achieve optimal results if you fill the feed tube **A2** gradually and push the ingredients down gently.



Attention:

Do not use fingers or other utensils to push ingredients through the feed tube **A2**. Always use the pusher **A1** designed for this purpose. The maximum time of non-stop operation of this appliance is 15 minutes. Then allow it to cool down for 10 minutes. When juicing larger batches of ingredients, do not run the appliance non-stop for longer than 10 seconds.

- If the juice jug **A11** or pulp container **A13** fill up during the juicing process, turn the juicer off by setting the 0/I switch **A8** to position 0 – off, empty out the respective container and then put it back in its place. Then you can put the juicer back into operation and continue juicing.
- To turn off the juicer, set the 0/I switch **A8** to position 0 – off. Then disconnect the juicer from the power socket. Allow the juice to flow out, then turn the DripStop **A12a** to the left to prevent dripping.
- When you have finished using the juicer, disassemble it according to the instructions contained in chapter Disassembling the juicer and clean it out according to the instructions contained in chapter Cleaning and maintenance. Before disassembling the juicer, make sure that the juicer is turned off (0/I switch **A8** is in position 0 – off), disconnected from the power socket and that the rotating parts have stopped.

USEFUL ADVICE AND TIPS

- Before you start juicing, thoroughly wash all the ingredients and cut them up into smaller pieces that will pass through the feed tube **A2**. Remove hard stones that are contained in, for example, apricots, peaches, mangoes, etc. and inedible peels, e.g. from oranges, pineapples, melons, mandarins, etc.
- To achieve optimal results, always process only fresh ripened fruits and vegetables. Overripe or unripe fruits and vegetables will negatively affect the resulting taste of the juice.
- If you juice fruits and vegetables of varying consistency, we recommend that you start with the softer fruits and vegetables, e.g. citruses, berries, etc. and then proceed on with harder fruits, e.g. apples. Always select a speed appropriate for the type of ingredients that are being juiced.
- Do not use the juicer for processing frozen or excessively hard ingredients, e.g. sugar cane.
- Place the ingredients into the feed tube **A2** gradually and push through gently with mild pressure. Do not overfill the feed tube **A2** and do not push the ingredients in too quickly and with excessive pressure. The process separating the juice from the pulp occurs gradually and will not be sped up by pushing ingredients in quickly.
- To prevent freshly pressed apple juice from turning brown, you can add a little lemon juice.
- To prevent losing valuable minerals, we recommended consuming the juice immediately after it is pressed.

DISASSEMBLING THE JUICER

- Check that you have turned off the juicer by setting the 0/I switch **A8** to position 0 – off and disconnected the power cord from the power source. Wait until rotating parts come to a complete stop before disassembly. Wait until the juice flows out and turn the DripStop **A12a** to the left to prevent the juice from dripping.
- Release the locking arm **A6** from the lid and tilt it downwards.
- Remove the lid **A3** and take out the pulp container **A13** by tilting the bottom away from the base unit. Then slide the pulp container from underneath the rim of the juice collector **A5**.
- Take out the juice collector **A5** with the titanium strainer **A4** still inside it by pulling it upwards away from the base unit **A7**.
- Take the titanium strainer **A4** out of the juice collector **A5**. We recommend that the strainer **A4** is removed over a kitchen sink.



Attention:

There is a blade in the middle part of the strainer **A4**. Be especially careful to avoid injury when handling the strainer **A4**. Do not touch the blade.

CLEANING AND MAINTENANCE

- Make sure that the juicer is turned off (the 0/I switch is in position 0 – off), the power cord is disconnected from the power source and that rotating parts have stopped.

- When the juicer is disassembled into its individual parts, clean it out according to the following instructions. The juicer will be easier to clean immediately after it has been used, before juice and pulp dries on to it.
- The pusher **A1**, titanium strainer **A4** and the pulp container **A13** may be washed in a dishwasher. We recommend washing the titanium strainer **A4** in the top rack of the dishwasher.

Cleaning the juicer

- Wipe the base unit of the juicer with a soft damp cloth and then dry thoroughly.
- Wipe any food remains from the power cord.

Cleaning the juice collector, lid, pusher, pulp container and juice jug

- Wash all parts in warm water with kitchen detergent. Rinse in clean water and dry.

Cleaning the strainer

- For effective juicing, it is necessary that the strainer **A4** is perfectly clean. Pulp dried on to the strainer **A4** would negatively affect juicing effectiveness.
- Immediately after you have finished juicing, soak the strainer **A4** in hot water with kitchen detergent for approximately 10 minutes.
- Hold the strainer **A4** under running water and clean it out using a nylon brush, going from the centre towards the edges. To prevent injury, do not touch the blade in the centre of the strainer. After cleaning the strainer **A4**, hold it against the light to check that the fine holes are not clogged. If the holes are still clogged, soak the strainer **A4** in hot water containing 10 % lemon juice to loosen the dried on remains and then clean it again using the brush.
- Then thoroughly rinse the strainer **A4** under clean running water and allow it to dry naturally.

Removing deposits, aggressive stains and odours

- Certain types of fruit and vegetables may cause discolouration of the plastic parts of the juicer. To prevent this from happening, rinse all removable parts immediately after use. If discolouration has already occurred, you may submerge the removable plastic parts into water containing 10% lemon juice.
- Do not submerge the base unit or its power cord in water or any other liquid, or wash these parts under running water.
- Do not use petrol, solvents, coarse sponges, abrasive or aggressive cleaning agents to clean the juicer.

STORAGE

- When not using the appliance, store it in a dry place out of children's reach. You can store the appliance assembled.

TECHNICAL SPECIFICATIONS

Rated voltage range	220–240 V
Rated frequency	50/60 Hz
Rated power input	1,200 W
Electrical shock protection class	2
Noise level	85 dB(A)

The declared noise emission level of the appliance is 85 dB(A), which represents a level A of acoustic power with respect to a reference acoustic power of 1 pW.

Explanation of technical terminology

Safety class for electrical shock protection:

Class II – electrical shock protection is provided by double or heavy-duty insulation.

Changes to text and technical parameters are reserved.

INSTRUCTIONS AND INFORMATION REGARDING THE DISPOSAL OF USED PACKAGING MATERIALS

Dispose of used packaging material at a site designated for waste in your municipality.

DISPOSAL OF USED ELECTRICAL AND ELECTRONIC EQUIPMENT



This symbol on products or original documents means that used electric or electronic products must not be added to ordinary municipal waste. For proper disposal, renewal and recycling hand over these appliances to determined collection points. Alternatively, in some European Union states or other European countries you may return your appliances to the local retailer when buying an equivalent new appliance.



Correct disposal of this product helps save valuable natural resources and prevents potential negative effects on the environment and human health, which could result from improper waste disposal. Ask your local authorities or collection facility for more details. In accordance with national regulations penalties may be imposed for the incorrect disposal of this type of waste.

For business entities in European Union states

If you want to dispose of electric or electronic appliances, ask your retailer or supplier for the necessary information.

Disposal in other countries outside the European Union.

This symbol is valid in the European Union. If you wish to dispose of this product, request the necessary information about the correct disposal method from the local council or from your retailer.



This appliance meets all the basic requirements of EU directives related to it.